



CI200-LW

Pulse Counter

User guide

CI200-LW_3-EN-154010-1.2
© All rights reserved.
Subject to technical changes and misprints.

Contents

1. Introduction	2
1.1. LoRaWAN device codification	2
1.2. Terms and abbreviations	2
1.3. Symbols and key words.....	3
1.4. Recycling and disposal.....	3
1.5. Intended use	3
1.6. Limitation of liability	3
1.7. Safety	3
2. Overview	4
3. Specifications and environmental conditions	5
3.1. Specifications	5
3.2. Environmental conditions	6
4. Operation	7
5. Configuration	8
6. Device settings	12
7. Indication	15
8. Connection	16
9. Mounting	18
10. Maintenance	19
11. Transportation and storage	20
12. Scope of delivery	21

1 Introduction

This user guide is intended to familiarize the operating personnel with the principle of operation, design, operation and maintenance of the CI200-LW pulse counter, hereinafter referred to as "device" or "CI200-LW".

Connection, setup and maintenance of the device must be performed only by fully qualified personnel after reading this user guide.

1.1 LoRaWAN device codification

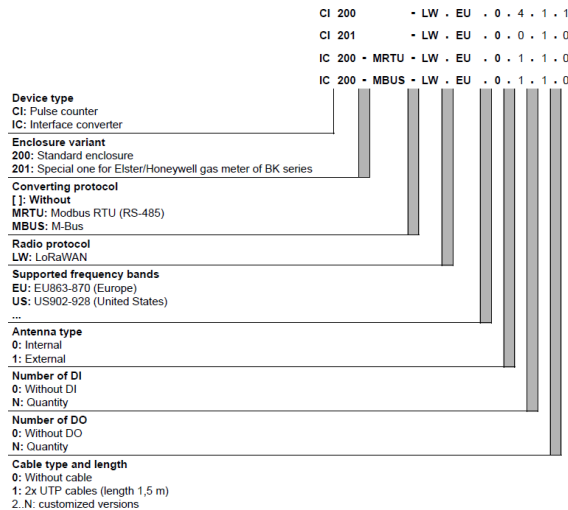

Fig. 1.1 LoRaWAN device codification

1.2 Terms and abbreviations

- **ABP (Activation by Personalization)** – LoRaWAN device activation method
- **ADR** – Adaptive Data Rate
- **AppEUI (Application Extended Unique Identifier)** – Unique application ID
- **AppKey (Application key)** – Server key
- **AppSKey (Application Session Key)** – Unique encryption key
- **Bluetooth** – Short-range wireless communication technology
- **DevAddr (Device address)** – Device address in the LoRaWAN network
- **DevEUI (Device Extended Unique Identifier)** – Unique device ID
- **Downlink message** – Message sent by the Network Server to only one end device
- **FIFO (First In, First Out)** – Data processing method
- **LoRaWAN (Long Range Wide Area Network)** – Wireless data transmission technology
- **NFC (Near Field Communication)** – Short-range wireless communication technology
- **NwkSKey** – Unique encryption key
- **OTAA (Over-the-Air-Activation)** – LoRaWAN device activation method
- **Hibernation** – Energy-saving device mode
- **Android OS** – Operating system for smartphones and other devices
- **iOS (iPhone OS)** – Operating system for smartphones and other devices
- **Class A LoRaWAN device** – Class A devices support bi-directional communication between the end device and the network. Communication is only initiated by the end device, then a response from the network is awaited within two windows at specified times.
- **Class C LoRaWAN device** – Class C devices keep the receive windows open unless they are transmitting.
- **DI** – Digital Input
- **DO** – Digital Output
- **MTBF** – Mean Time Between Failures
- **MCU** – Microcontroller Unit

1 Introduction

1.3 Symbols and key words



DANGER
WARNING indicates a potentially dangerous situation that could result in death or serious injuries.



CAUTION
CAUTION indicates a potentially dangerous situation that could result in minor injuries.



NOTICE
NOTICE indicates a potentially dangerous situation that could result in damage to property.



NOTE
NOTE indicates helpful tips and recommendations, as well as information for efficient and trouble-free operation.

1.4 Recycling and disposal



The device is considered an electronics device for disposal in terms of European Directive 2012/19/EU and may not be disposed of as domestic garbage.

- Dispose of the device through channels provided for this purpose.
- Comply with all local and currently applicable laws and regulations.

1.5 Intended use

The device has been designed and built solely for the intended use described here, and may only be used accordingly. The technical specifications contained in this document must be observed. The device may be operated only in properly installed condition.

Improper use

Any other use is considered improper. Especially to note:

- The device may not be used for medical applications.
- The device may not be used in an explosive environment.
- The device may not be used in an atmosphere in which there are chemically active substances.

1.6 Limitation of liability

Our company does not bear any responsibility with respect to breakdowns or damages caused by using the product in a manner other than described in the manual or in violation of the current regulations and technical standards.

1.7 Safety



DANGER
Ensure the mains voltage matches the voltage marked on the nameplate.



DANGER
The device terminals may be under a dangerous voltage. De-energize the device before working on it. Switch on the power supply only after completing all work on the device.



NOTICE
Supply voltage must not exceed the specified voltage. Higher voltage can damage the device.



NOTICE
If the device is brought from a cold to a warm environment, condensation may form inside the device. To avoid damage to the device, keep the device in the warm environment for at least 1 hour before powering on.

2 Overview

The CI200-LW pulse counter is designed to monitor the state of digital inputs (pulse counting or alarm detection), store and transmit measurements via the LoRaWAN network. The device is battery-powered and can be connected to an external DC power supply. Pulse inputs can be configured as security inputs. In this case, there is no pulse counting at the input and the device sends an unscheduled notification when the state of the security input changes.

Basic features

- Data transmission: LoRaWAN 1.0.4 Class A; when powered by an external source, Class C
- Data collection: Pulse inputs, security inputs
- Power: 2 x ER18505, external power supply
- Enclosure: ABS+PC
- Mounting: Wall-mounted, on a DIN rail using an adapter, on a pipe/mast using stainless steel cable ties (or nylon zip cable ties)
- Data exchange protocol: akYtec Protocol
- Configuring the device: Via Bluetooth using the mobile application and remote via the LoRaWAN Server by sending downlink messages to the device
- Firmware update: Via Bluetooth using the mobile application

Usage

The pulse counter is designed to build automated information and measurement systems for resource accounting, monitoring, dispatching, to monitor states and control equipment operating modes as part of smart home/smart city projects, housing and utilities, industry, and other fields.

Dimensions

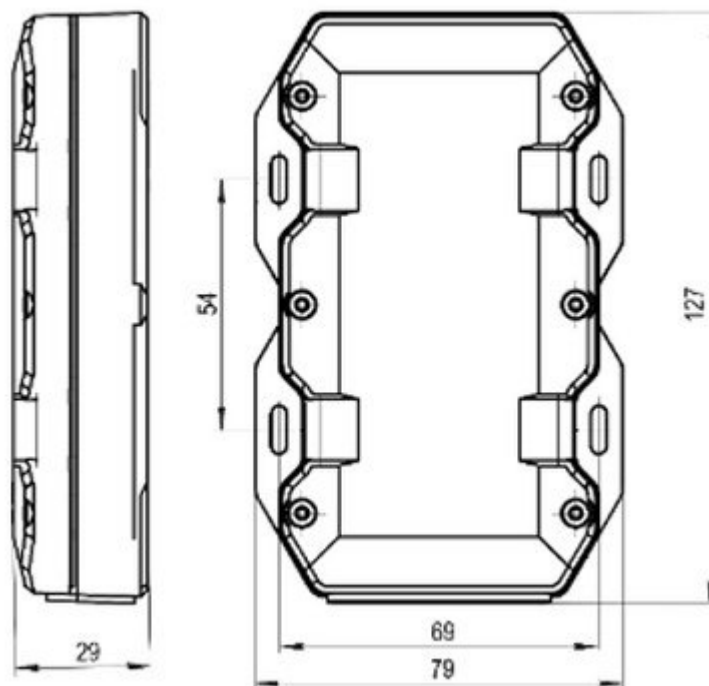

Fig. 2.1 Dimensions

3 Specifications and environmental conditions

3.1 Specifications

Parameter	Value
Data transmission interface	
Data transmission	LoRaWAN 1.0.4, Class A, C
Frequency bands	EU868 - default, US915 and others - by request
ADR support	Yes
Transmitter power, max.	+20 dBm, 100 mW
Receiver sensitivity	-137 dBm
Data transmission period	1, 5, 10 or 30 min 1, 4, 6, 12 or 24 hours
Memory capacity for storing packets	20 000 packets
Activation method	ABP/OTAA
Antenna type	Internal/External (by request)
Encryption algorithm	Hardware AES-128
Configuration interface	
Device initialization	NFC-A
Device setup	Bluetooth LE 5.1
Configuration software	
Mobile application	akYtec IoT Configurator
Digital/Pulse input	
Number	4
Operating mode switching	Software
Frequency of registered pulses, max., Hz	100 (200 Hz, with additional EMI protection)
Internal pull-up to device power supply	Yes
ESD protection	Yes
Type of connected devices	"Dry contact", open collector
Digital output	
Number	1
Type	Open collector
Maximum load current	1 A
Switching voltage	Up to 24 V
Memory	
Type	Flash
Built-in memory size	8 MB

Parameter	Value
Power supply	
Battery voltage	3.6 V
Battery type	2 × ER18505
Total capacity	4000 mAh*
Battery life	Up to 5 years (depending on settings)
External DC power supply	5...30 V
External DC power bank	5...16 V
Mechanical	
Color	RAL 7035 (light gray)
Enclosure	ABS+PC plastic
IP code	IP65
Dimensions	129 x 79 x 29 mm
Weight, max.	195 g
MTBF	50 000 hours



NOTE

*Can be changed.

3.2 Environmental conditions

The device is designed for natural convection cooling which should be taken into account when choosing the installation site.

The following environmental conditions must be observed:

- non-hazardous areas, free of corrosive or flammable gases

Table 3.1 Environmental conditions

Condition	Permissible range
Ambient temperature, operation and transportation	-40...+70 °C
Ambient temperature, storage	+5...+40 °C
Relative humidity, operation	10...95 % (non-condensing)
Relative humidity, storage	up to 85%
Altitude	up to 2000 m ASL
Regulations and certifications	conforms to Directive 2014/53/UE (RED) and RoHS

4 Operation

4 Operation

The device is delivered in an inactive mode (hibernation). The hibernation mode is intended for storage and transportation. To start the device, disable this mode. Activate the device with the help of NFC.

To start up the device:

- Switch on the NFC interface on your smartphone.
- Hold your smartphone close to the NFC mark on the front panel of the device to activate it.
- After device activation, configure it via Bluetooth using a mobile application.

The device's pulse input can be connected to external equipment and resource meters with pulse outputs. In the security mode, the input can be used to monitor the triggering of external sensors, such as:

- Leakage sensor
- Meter cabinet door opening sensor
- Water pipe pressure relay
- Electronic seal, etc.



NOTICE

The type of connected devices is "dry contact" or open collector.

The device has one digital output to control external actuators such as:

- Electromechanical water/gas shut-off valve, etc.
- Signaling device



NOTICE

The digital output uses as an NPN open-collector transistor. Maximum load current is 1 A. Switching voltage is up to 24 V.

The device is equipped with a tamper sensor that detects when the enclosure is opened. You can find information about its status in the **Personalization** tab of the application. If the enclosure opening status changes, unscheduled packet transmission may occur (depending on the settings).

The device operates as a LoRaWAN® Class A device when powered by the battery or as a Class C device when powered by an external power supply.

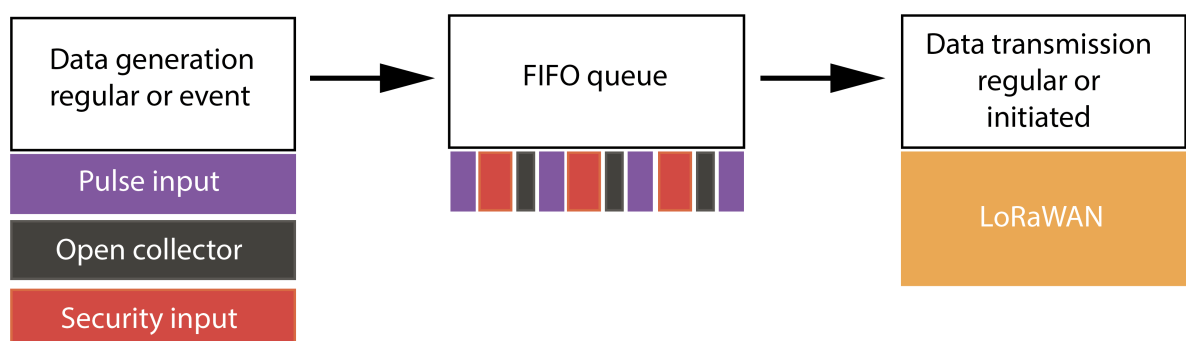

The device has several modules that generate data, a module for data transmission, and an intermediate FIFO queue.

The queue can store up to 20 000 untransmitted data packets and operates on a FIFO basis. The oldest data is transmitted first. If the device leaves the network coverage area, all measured data will be stored and transmitted when the device returns to the network.

5 Configuration

The device provides two ways to change device configuration parameters:

- Local: Via a mobile application
- Remote: By sending a downlink message to the device from the server using the akYtec Protocol

Mobile application

- Go to the device page on the akYtec website via the QR code and download the mobile application in a convenient way. The full version of the user guide is also available on the website.
- Download the **akYtec IoT Configurator** mobile application to your smartphone.
- Install and connect the device.



Connection to the device

1. Start **akYtec IoT Configurator**.



NOTE

Before launching the application, please ensure that Bluetooth is enabled.



NOTE

For Android smartphones, you also need to enable geolocation, otherwise the mobile application cannot connect to the device. This is a requirement of the Android operating system.

2. Select your device. Please note that it may take 10-15 seconds before your device appears in the list.
3. Enter a password.



NOTE

The default password (factory settings) for the device is **1111**.
Change the default password before device usage.

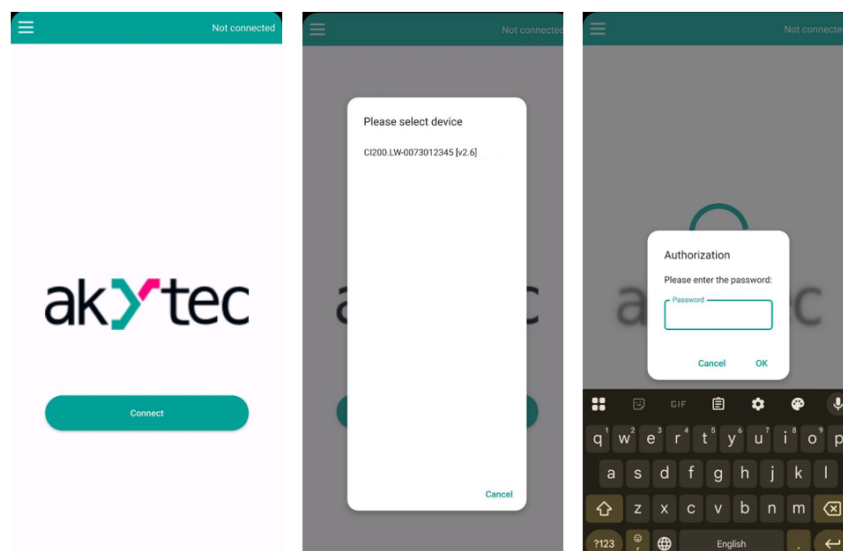

Fig. 5.1 Device connection using **akYtec IoT Configurator**

Application features

You can control the device using:

- **Settings:** Device configuration
- **State:** Check the current status of the device
- **Commands:** Send commands to the device
- **Personalization:** Personalization data and tamper status
- **Debug:** Check logs and update firmware (for Android only)

Settings

Open the **Settings** tab to change the device settings.
After editing the settings, click the **Save** button.



Commands

Open the **Commands** tab to perform the following actions.

Table 5.1 Commands

Command	Description
Reboot	Restart the device.
Restore default settings	Reset the factory settings.
Erase flash	Erase flash memory.
Rejoin	Start the network registration.
Run measurement	Start the interface polling procedure.
Send packet	Force the data transmission.
Run QA test	Start automatic device testing (for service staff only).
Manual reset alarm	Manually reset the alarm state.
Turn on DO and switch DO to auto mode after N min.	Enable/Disable the digital output and switch the port to the automatic mode* after N minutes. This command enables/disables the digital output regardless of time (minutes) specified in settings. After the time has elapsed, the digital output returns to the state according to the settings.
Turn off DO and switch DO to auto mode after N min.	
Setting DO automatic mode	Set the automatic mode of the digital output (DO).
Find device	Enable intense indication.
Reset counters	Reset the stored values of pulse inputs.
Device tamper flag reset	Reset tamper alarm.

**NOTE**

*Automatic control mode of the Digital Output:

- An input is set to the security mode (Alarm Closed/Alarm Opened): **Alarm Closed** – alarm if the input is closed; **Alarm Opened** – alarm if the input is open.
- If **Dlx: alarm output control** is enabled (see the **Digital Output (DO)** settings), then in case of alarm the Digital Output (DO) operates depending on **State in Alarm mode**: **OFF** – the Digital Output (DO) switches off, **ON** – the Digital Output (DO) switches on.
- If necessary to set the automatic mode immediately, use the command **Setting DO automatic mode**.

Personalization**General:**

- Serial number: Device serial number
- Root password: Password to access the device via the **akYtec IoT Configurator** application with administrator rights (default password: 1111)
- User password: Password to access the device via the **akYtec IoT Configurator** application with user rights (default password: 2222)

OTAA keys:

- DevEUI: Unique device ID in the LoRaWAN network
- AppEUI: Unique application ID to identify the application provider
- AppKey: Application key used to get NwkSKey and AppSKey session keys

ABP keys:

- DevAddr: Unique device ID in the LoRaWAN network
- AppSKey: Unique encryption key
- NwkSKey: Unique encryption key

Other:

- LoRa session counter: LoRaWAN network session counter
- Successfully sent packets counter: Counter of successfully sent packets
- Time to switch Digital Output to automode: Time until the digital output (DO) switches to the automatic mode
- Registration of external influence: Status of external magnet influence registration
- Device was opened: Tamper alarm (to reset it, open the **Commands** tab)

Debug

Open the **Debug** tab to view the progress of device operation algorithms.

The **Debug** tab allows you to:

- Copy the history of algorithm execution
- Delete the history
- Update the firmware (for Android only)

Firmware update

To update the firmware:

- Download the firmware file to your mobile device and place it in the root directory of your Android smartphone.
- Start the **akYtec IoT Configurator** mobile application on the smartphone.

**NOTE**

Go to the device page on the akYtec website via the QR code and download the mobile application in a convenient way. The full version of the user guide is also available on the website.



- When you start the application, the application window appears. Click the **Connect** button and select the desired device by tapping its name.
- After selecting the device, enter the password to access the device (default password: 1111).

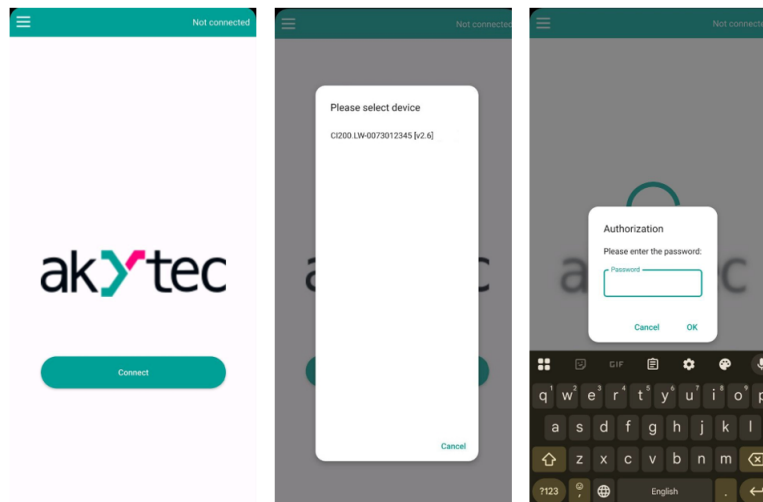



Fig. 5.2 Device connection using akYtec IoT Configurator

- Click the  menu pictogram in the top left corner. In the opened window, click the **Debug** tab. Click the **Update firmware** button at the bottom of the **Debug** tab.

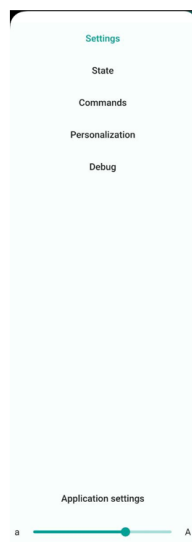

Fig. 5.3 Drop-down menu

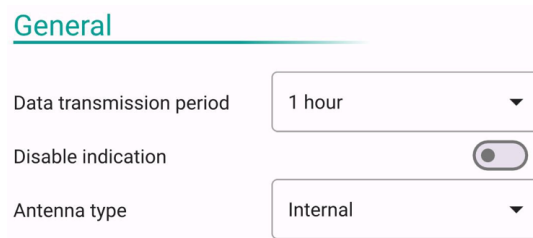

Fig. 5.4 Firmware update

- Select the firmware file with extension *.bin (navigate to the file using your mobile phone's file explorer). After selecting the firmware file, the update will begin. When it is complete, the message “Firmware successfully updated” will appear.

6 Device settings

General



The screenshot shows the 'General' settings page with the following options:

- Data transmission period:** A dropdown menu set to '1 hour'.
- Disable indication:** A toggle switch that is currently turned on.
- Antenna type:** A dropdown menu set to 'Internal'.

- **Data transmission period:** The period to send accumulated data to the server. If there are no packets in the queue at the time of sending, the communication session will be skipped. You can set the value from the range: 1 minute, 5 minutes, 10 minutes, 30 minutes, 1 hour, 4 hours, 6 hours, 12 hours or 24 hours. The data transmission period may not match the data collection period.
- **Disable indication:** Disable light indication.
- **Antenna type:** Select the antenna type (Internal or External).

Hibernation



The screenshot shows the 'Hibernation' settings page with the following option:

- Hibernation mode:** A toggle switch that is currently turned on.

The device has a hibernation mode that can be enabled/disabled. The device is transported and stored in the hibernation mode. In the hibernation mode, none of the device modules are running, the device remains in the energy-saving mode. To exit the hibernation mode, hold your smartphone with the enabled NFC close to the NFC mark on the front panel of the device.

LoRaWAN

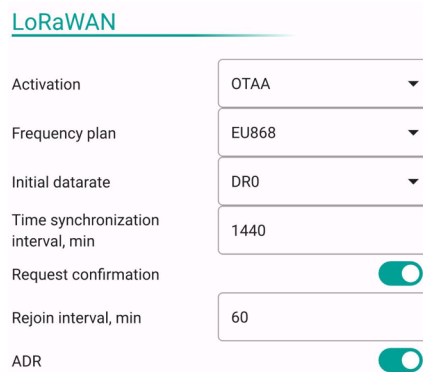

The screenshot shows the 'LoRaWAN' settings page with the following options:

- Activation:** A dropdown menu set to 'OTAA'.
- Frequency plan:** A dropdown menu set to 'EU868'.
- Initial datarate:** A dropdown menu set to 'DR0'.
- Time synchronization interval, min:** A text input field set to '1440'.
- Request confirmation:** A toggle switch that is currently turned on.
- Rejoin interval, min:** A text input field set to '60'.
- ADR:** A toggle switch that is currently turned on.

The device can regularly send data via the LoRaWAN network. The device supports LoRaWAN version 1.0.4, activation methods ABP/OTAA.

- **Activation:** Select the activation method in the network (ABP/OTAA).
- **Frequency plan:** Select the region where your device is located. The device applies the configuration according to the regional settings of the selected region. Please ensure that the selected region matches the device hardware version.
- **Initial datarate:** LoRaWAN data transmission rate
- **Time synchronization interval, min.:** Clock synchronization period
- **Request confirmation:** Enable if you need confirmation that data is successfully received by the server. If enabled, the device doesn't delete packets from the queue until it receives the confirmation about packet delivery from the network. If disabled, the device immediately deletes packets from the queue after transmission, regardless of whether they have been received by the network or not.

6 Device settings

- **Rejoin interval, min.:** Interval at which the device will attempt to connect to the network. This option is only used if the device is still not connected to the network.
- **ADR:** Enable the algorithm to adjust the data transmission rate.

LoRaWAN data transmission rate:

- DR0
- DR1
- DR2
- DR3
- DR4
- DR5



NOTE

Disabled confirmation reduces the load on the LoRaWAN network and increases the network throughput, but may result in packet loss. Please disable this setting if you clearly understand what you are doing.

You can find DevEUI and keys on the **Personalization** tab.

Use **Rejoin** on the **Commands** tab to force the network connection.

Digital Input (DI)

The device has 4 Digital Inputs (DI1, DI2, DI3, DI4).

Digital Input 1 (DI1)

Operating mode	Counter
Data retention period	1 hour
Closed state time (ms)	5
Open state time (ms)	2
Auto-reset alarm, s (0 - manual reset of alarm)	0
Emergency messages sending in case of alarm on port	<input checked="" type="checkbox"/>
Emergency messages sending after alarm recovery on port	<input type="checkbox"/>

- **Operation mode:**
 - **Counter:** The input operates in the pulse counter mode.
 - **Alarm Opened:** The input operates as a security input (NC – normally closed).
 - **Alarm Closed:** The input operates as a security input (NO – normally open).
 - **Disable:** Digital input is disabled.
- **Data retention period:** Select the period for data retention. The device continuously monitors the input state and stores measurement packets in a queue for subsequent transmission. Packets are sent to the server according to the set data transmission period. The data collection period is 1 minute, 5 minutes, 10 minutes, 30 minutes, 1 hour, 4 hours, 6 hours, 12 hours or 24 hours.
- **Closed state time (ms):** Time to detect the pulse presence and eliminate false registration to enter the pulse counter mode
- **Open state time (ms):** Time to detect the pulse absence and eliminate false registration to enter the pulse counter mode
- **Auto-reset alarm, s:** Alarm reset period for this input
- **Emergency messages sending in case of alarm on port:** Packet transmission mode when the digital input is in the alarm state
- **Emergency messages sending after alarm recovery on port:** Packet transmission mode when the digital input returns to the normal state.

6 Device settings



NOTE

Packets are generated and placed in the queue for transmission at any change of digital input state. This feature makes emergency communication possible. The structure of these packets doesn't differ from the packets that are generated in accordance with the queue.



NOTICE

The type of connected device is "dry contact" or open collector.

Digital Output (DO)

Digital Output (DO)

State in Alarm mode	ON
D11: alarm output control	<input checked="" type="checkbox"/>
D12: alarm output control	<input type="checkbox"/>
D13: alarm output control	<input type="checkbox"/>
D14: alarm output control	<input type="checkbox"/>

- **State in Alarm mode:** Select the state the DO should be when the alarm is triggered: **OFF** – the output is open, **ON** – the output is closed.
- If **Dix: alarm output control** is enabled, the DO state will depend on alarm status of DIx and will switch according to the setting of **State in Alarm mode**.



NOTICE

The digital output uses an NPN open-collector transistor. Maximum load current is 1 A. Switching voltage is up to 24 V.

MCU temperature sensor



MCU temperature sensor

Enabled	<input checked="" type="checkbox"/>
Measurement period, min	30
Enable sending of temperature data	<input type="checkbox"/>

- **Enabled:** Enable/Disable temperature sensor
- **Measurement period, min:** Period of temperature sensor measurement
- **Enable sending of temperature data:** Unscheduled data transmission after temperature sensor measurement

7 Indication

You can disable/enable indication in **Setting > General > Disable indication**.

-  **External power supply indication:** The indicator flashes red when the external supply is 5 V to 9 V. The indicator is solid red when the external supply is greater than 9 V.
-  **Data successfully received by the server**
-  **Data transmission indication:** During data transmission the indicator flashes blue. Upon successful packet transmission, if the confirmation of successful packet transmission is enabled, the green indicator will flash once.

8 Connection

The device has two cables marked with inscriptions on the back of the enclosure.

Fig. 8.1 shows the correspondence between the colors of the wires and the inputs, outputs, and wires for connecting power sources.

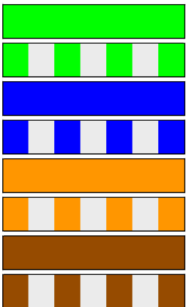

Color	Cable #1	Cable #2
Green	DI1	DO
Green-White	COM1	COM
Blue	DI2	BAT
Blue-White	COM2	-
Orange	DI3	24V
Orange-White	COM3	-
Brown	DI4	0V
Brown-White	COM4	-

Fig. 8.1 Pin assignment

Digital input

Use the DIx and COM contacts to connect an external sensor with a digital output.

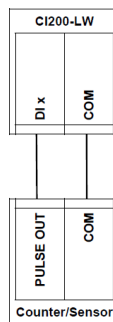

Fig. 8.2 Sensor connection diagram



NOTICE

The type of connected device is “dry contact” or open collector.

Digital output

Use the DO and COM contacts to connect an external actuator.

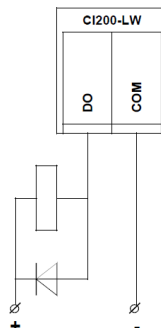

Fig. 8.3 External device connection diagram



NOTICE

The digital output uses an NPN open-collector transistor. Maximum load current is 1 A. Switching voltage is up to 24 V.

Power supply

Use contacts 24 V and 0 V to connect an external power supply. This input has the extended range of voltage: 5-30 V.

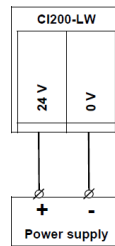

Fig. 8.4 Power supply connection diagram

Power bank

Use contacts BAT and 0 V to connect an external power bank. This input has high efficiency that extends operating time from an external power bank. It supports the voltage range of 5-16 V.

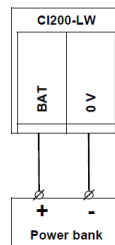

Fig. 8.5 Power bank connection diagram

9 Mounting

To mount the device on the DIN rail, install the universal bracket in the standard mounting seat. To mount the device on a wall or any flat surface, use 4 holes for screws in the device enclosure. Use the same holes to fasten the device on a pipe with stainless steel cable ties (or nylon zip cable ties).

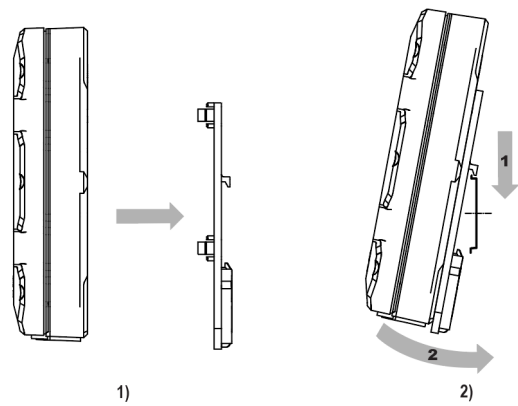

Fig. 9.1 DIN rail mounting

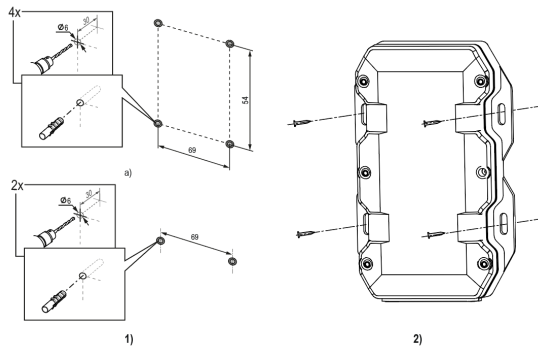

Fig. 9.2 Wall mounting

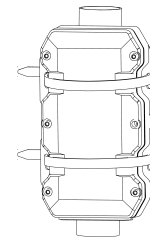

Fig. 9.3 Mounting with cable ties

10 Maintenance

The safety requirements must be observed when the maintenance is carried out.



DANGER

Cut off all power before maintenance.

The maintenance includes:

- cleaning the housing and terminal blocks from dust, dirt and debris
- checking the device fastening
- checking the wiring (connecting wires, terminal connections, absence of mechanical damages).



NOTICE

The device should be cleaned with a dry or slightly damp cloth only. No abrasives or solvent-containing cleaners may be used.

11 Transportation and storage

The device is transported and stored in the hibernation (inactive) mode.

The original packaging provides optimum protection.

If the device is not taken immediately after delivery into operation, it must be carefully stored at a protected location. The device should not be stored in an atmosphere with chemically active substances.

The environmental conditions must be taken into account during transportation and storage.



NOTICE

The device may have been damaged during transportation.

Check the device for transport damage and completeness!

Report the transport damage immediately to the shipper and akYtec GmbH!

12 Scope of delivery

- | | |
|----------------|-------|
| – CI200-LW | 1 pc. |
| – Mounting set | 1 pc. |
| – Short guide | 1 pc. |

 **NOTE** | The manufacturer reserves the right to make changes to the scope of delivery.