

**RS232-RS485 Converter**

**Safety**



**DANGER** *Dangerous voltage  
Electric shock could kill or seriously injure.  
All electrical connections must be performed by a fully qualified electrician.  
Ensure that the mains voltage matches the voltage marked on the device.  
Ensure that the device is provided with its own power supply line and electric fuse.*



**WARNING** *Switch on the power supply only after wiring of the device has been completed.*

**Overview**

IC3 is a bidirectional RS232-to-RS485 converter. With this device you can connect any RS485 device directly to the serial RS232 COM port of your PC or another device. This converter supports automatic control of the direction of transmission, so no software drivers are required. All standard protocols for RS232 and RS485 interfaces are supported.

IC3 can be ordered in various designs depending on the required supply voltage. Ordering key:

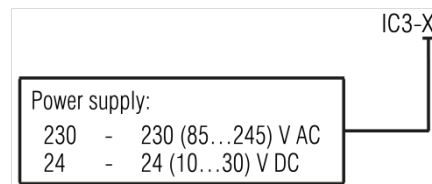
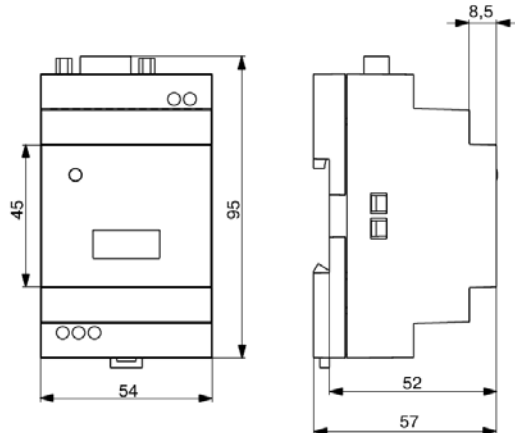

Fig. 1 Dimensions

**Specification**

Table 1 General specification

Power supply	IC3-230	230 (85...245) V AC, 50 (47...60) Hz
	IC3-24	24 (10...30) V DC
Power consumption, max.		0.5 VA
Galvanic isolation		1500 V
RS232 Interface		
Cable length, max.		3 m
Baud rate		up to 115.2 kbit/s
Signals		TxD, RxD, GND
RS485 Interface		
Cable length, max.		1200 m
Number of devices in the network, max.		32
Terminals		D+, D-
Dimensions		54 x 95 x 57 mm
Mounting		DIN rail (35 mm)
Weight		approx. 100 g

**Environmental conditions**

The device is designed for natural convection cooling that should be taken into account when choosing the installation site.

The following environment conditions must be observed:

- clean, dry and controlled environment, low dust level
- closed non-hazardous areas, free of corrosive or flammable gases

Table 2 Environmental conditions

Condition	Permissible range
Ambient temperature	-20...+75°C
Storage temperature	-25...+55°C
Relative humidity	up to 80% (at +25°C, non-condensing)
Altitude	up to 2000 m above sea level
IP code	IP20

RS232-RS485 Converter

Control elements

Front side:

- LED „RS-232 <=> RS-485“ - status indication (see Table 3)

Upper side:

- RS232 port (DB9-F)





Lower side:

- RS485 terminals (see Fig. 2)
- DIP switches - selection of a built-in terminating resistors (see Table 4)

Table 3 Status indicators

LED	Description
ON	Power supply OK
OFF	Supply voltage too low or no power failure
flashing	Data exchange

Table 4 DIP switches

Position *	Terminating resistor	Position *	Terminating resistor
	not used		120 ohm ±5%
	620 ohm ±5%		100 ohm ±5%

\* White – switch position

Installation

The device is designed in a plastic enclosure for DIN rail mounting (see Fig. 1).

The device should be connected according to the diagram shown in the Fig. 2:

- Connect the IC3 to the PC or another device over the RS232 interface
- Connect the terminals D+, D- of the IC3 to the correspondent terminals of RS485 network (or device)
- For the connection to the RS485 network the twisted pair cable should be used
- Ensure that the IC3-230 is provided with its own power supply line and an electric fuse I = 1 A
- The maximum conductor cross-section is 0.75 mm<sup>2</sup>

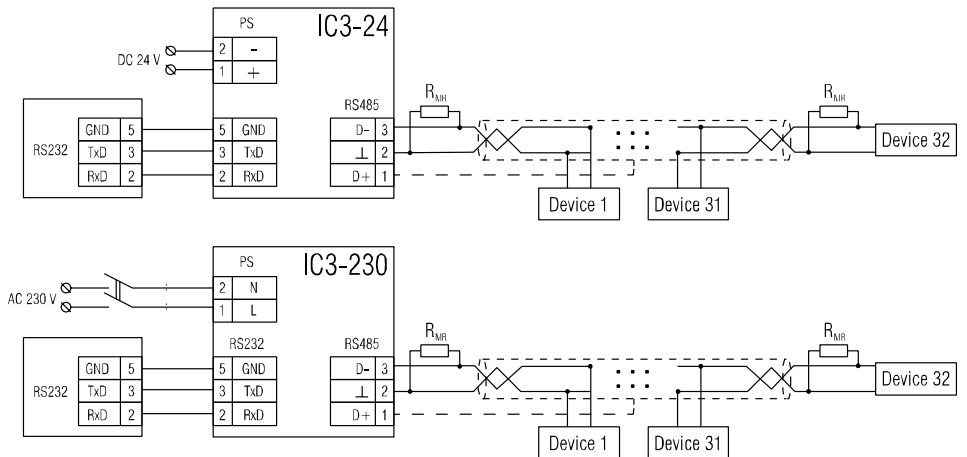

Fig. 2 Wiring

Maintenance

The maintenance includes:

- checking the fastening of the device
- checking the wiring (connecting leads, fastenings, mechanical damage)
- cleaning of the housing and terminal blocks from dust, dirt and debris

The device should be cleaned with a damp cloth only. No abrasives or solvent-containing cleaners may be used. When carrying out maintenance the safety information must be observed.

Transport and storage

Pack the device in such a way as to protect it reliably against impact for storage and transportation. The original packaging provides optimum protection.

If the device is not taken immediately after delivery into operation, it must be carefully stored at a protected location. The device should not be stored in an atmosphere with chemically active substances.

Scope of delivery

- IC3 1
- User guide 1