

Data logger

- ▶ **NOTICE** | It is necessary to observe the polarity while connecting 24V power sources. Improper connection can damage the device.
- ▶ **NOTICE** | Device must be powered off before connecting to PC.
- ▶ **NOTICE** | When connecting MSD200 to a stationary PC, make sure that the computer provides grounding (this requirement does not apply to notebooks).
- ▶ **NOTICE** | Dismounting of the terminal blocks may be performed only after powering off the device and all connected equipment.
- ▶ **NOTICE** | While using the USB connection, RS485 interface RS1 is temporarily disabled. When USB interface is disconnected, interface RS1 is available again.
- ▶ **NOTICE** | A twisted pair cable should be used to connect an external device to the RS232 / RS485 interface.

Table 1 Specifications

Power supply	24 (20...33) V DC
Power consumption	5 W
Basic accuracy	±1.0%
Analog inputs	4
Input signal	0-5 mA, 0-20 mA, 4-20 mA
Sampling time (analog inputs)	100 ms
Input resistance	133 ohm
Galvanic isolation between analog inputs	none
Logging channels	64
Data set size (per channel), max.	20 byte
Storage media	MMC, SD, SDHC, microSD
Storage capacity, max.	32 GB
Storage medium file system	FAT32
Data transfer rate over USB	79 kByte/s
Dimensions	23 x 100 x 120 mm
IP Code	IP20
Backup time	2 years
Weight	approx. 150 g

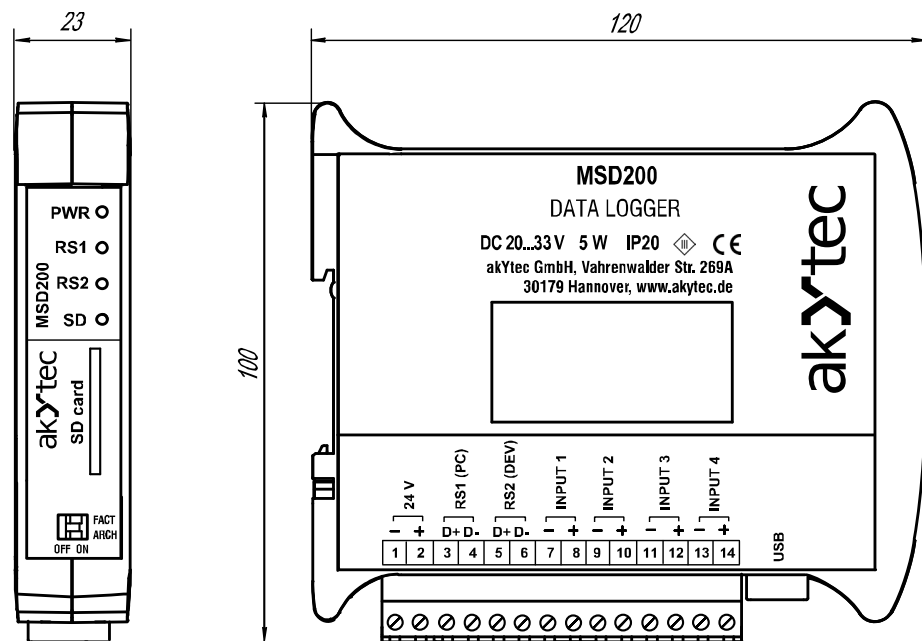

Fig. 1 Dimensions

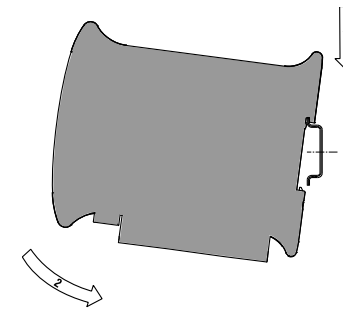

Fig. 2 Mounting on the DIN-rail

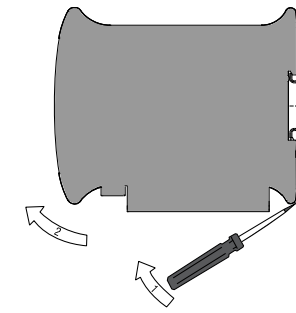

Fig. 3 Removing PR200 from the DIN rail

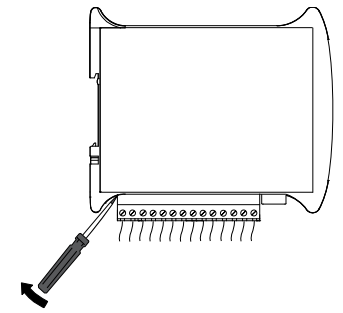

Fig. 4 Quick replacement of terminal blocks

Removal:

- Take off the terminal blocks without disconnecting the wires (Fig. 4)
- Insert a screwdriver into the eyelet of the slide interlock (Fig. 4)
- Loosen the slide interlock by pushing it with the screwdriver in direction of arrow 1, then remove device from the DIN rail in direction of arrow 2.

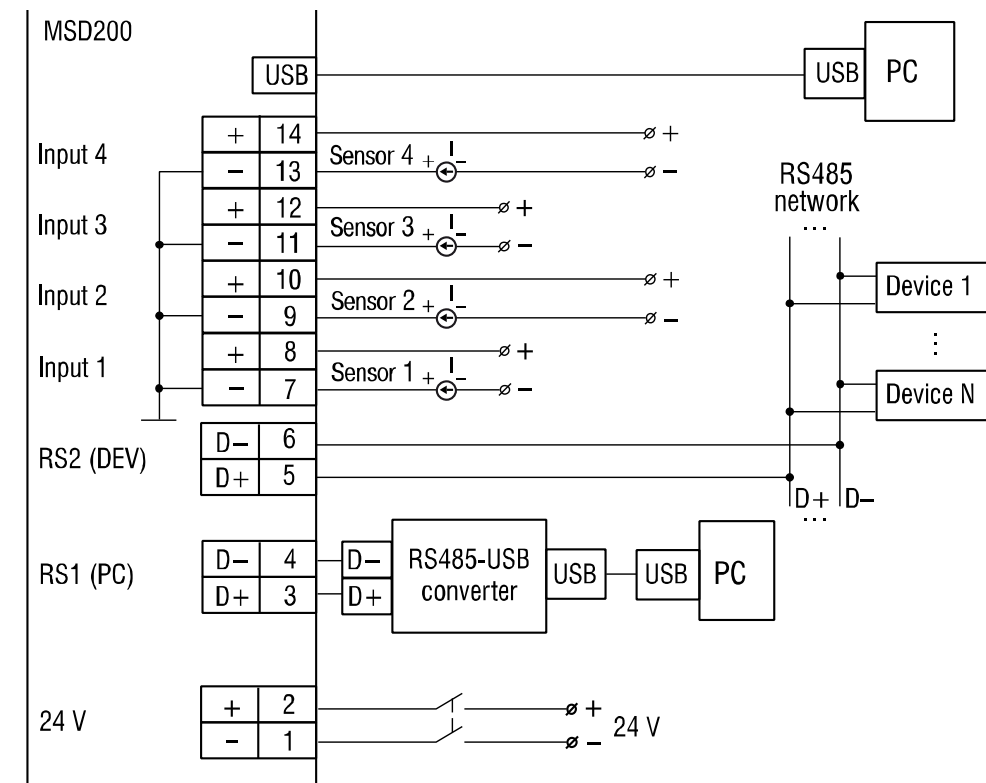

Fig. 5 Layout of external connections