



## MSD200

### Data Logger

### User guide

## Contents

<b>Introduction</b> .....	<b>2</b>
<b>1. Overview</b> .....	<b>3</b>
<b>2. Specifications</b> .....	<b>4</b>
2.1. Galvanic isolation.....	5
2.2. Operating conditions.....	5
<b>3. Safety</b> .....	<b>6</b>
3.1. Intended use.....	6
<b>4. Design and functioning</b> .....	<b>7</b>
4.1. Design.....	7
4.2. Control elements.....	7
<b>5. Installation</b> .....	<b>9</b>
5.1. Mounting.....	9
5.2. Wiring.....	9
5.3. Quick replacement.....	11
<b>6. MSD200 Configurator</b> .....	<b>12</b>
6.1. Software overview.....	12
6.2. MSD200 – PC connection.....	13
6.2.1. Connection via RS232.....	14
6.2.2. Connection via modem.....	14
6.3. Channels.....	14
6.4. File Manager.....	16
6.5. View data.....	18
6.6. Settings.....	18
6.7. Digital signature.....	20
6.8. Date and Time.....	21
6.9. Log files.....	21
6.10. Analog inputs.....	22
<b>7. Memory card</b> .....	<b>23</b>
7.1. Saving data.....	23
7.2. Memory card replacing.....	23
<b>8. Modbus RTU</b> .....	<b>24</b>
<b>9. Maintenance</b> .....	<b>29</b>
<b>10. Transportation and Storage</b> .....	<b>30</b>
<b>11. Scope of delivery</b> .....	<b>31</b>

## Introduction

---

### Introduction

This manual describes the functions, configuration and operating of data logger MSD200.

### Terms and abbreviations

Following terms and abbreviations are used in the guide:

**Modbus** – application layer messaging protocol for client/server communication between devices connected on different types of buses or networks, originally published by Modicon (now Schneider Electric), currently supported by an independent organization Modbus-IDA ([www.modbus.org](http://www.modbus.org)).

**CSV** – plane text format designed for tabular data representation.

## Overview

---

### 1. Overview

MSD200 is intended for data monitoring and logging purposes and provides following functions:

- 4 analog inputs for standard electrical signals 0-5 mA, 0-20 mA or 4-20 mA
- scaling function to convert the measured value to any unit
- monitoring of data received from other devices via Modbus over RS485 interface
- logging the received data and store it as a hard-copy to a memory card as a CSV file
- exchange the data with other information and control systems via Modbus
- the device supports remote access over external modem
- MSD200 Configurator software enables to configure the device and provides a visual means of analyzing the process data

## Specifications

### 2. Specifications

Table 2.1 General specifications

Power supply	24 (20...32) V DC
Power consumption, max.	5 W
Log channels	64
Dataset size (per channel), max.	20 Byte
Analog inputs	4
Storage media	SD, SDHC, microSD, MMC
Storage medium capacity, max.	32 GB
Storage medium file system	FAT32
File type	*.CSV
Interfaces	2x RS485 (RS1, RS2); 1x USB
Logging cycle	1...65535 s
Backup time	2 years
Backup battery	CR2032
Dimensions	23 x 102 x 120 mm
Weight	approx. 150 g

Table 2.2 Analog inputs

Input signal	0-5 mA, 0-20 mA, 4-20 mA
Sampling time	100 ms
Basic accuracy	±1.0%
Input resistance	133 ohm
Galvanic isolation between channels	none

Table 2.3 RS485 interfaces

Operation mode	RS1 (PC)	Slave
	RS2 (DEV)	Master, Slave, Slave Ext, Spy*
Protocol	RS1 (PC)	ModBus RTU
	RS2 (DEV)	ModBus RTU, ModBus ASCII, akYtec
Baud rate	1.2...115.2 kbit/s	

\* only for akYtec protocol

Table 2.4 USB interface

Type	USB 2.0
Interface mode	Full-speed
Transport layer protocol	CDC
Application layer protocol	ModBus RTU
Baud rate USB	79 kB/s
Connector type	B
Cable type	USB A/B

## Specifications

### 2.1. Galvanic isolation

The data logger has 4 potential groups:

- Power supply 24 VDC
- Analog inputs, USB interface
- RS1 (PC) interface
- RS2 (DEV) interface

Galvanic isolation from each group to chassis                      500 V AC / 1 min

Galvanic isolation between groups                                      500 V AC / 1 min

### 2.2. Operating conditions

The following environment conditions must be met:

- clean, dry and controlled environment, low dust level
- closed non-hazardous areas, free of corrosive or flammable gases

Table 2.5





Condition	Permissible range
Ambient operating temperature	-10...+55°C
Storage temperature	-15...+55°C
Relative humidity	up to 80% (at +25°C, non-condensing)
IP Code	IP20
Altitude	up to 2000 m above sea level
EMC immunity	conforms to IEC 61000-6-2
EMC emission	conforms to IEC 61000-6-4

## Safety

---

### 3. Safety

Explanation of the symbols and keywords used:

	<b>DANGER</b>	<i><b>DANGER indicates an imminently hazardous situation which, if not avoided, will result in death or serious injury.</b></i>
	<b>WARNING</b>	<i><b>WARNING indicates a potentially hazardous situation which, if not avoided, could result in death or serious injury.</b></i>
	<b>CAUTION</b>	<i><b>CAUTION indicates a potentially hazardous situation which, if not avoided, could result in minor or moderate injury</b></i>
	<b>NOTICE</b>	<i><b>NOTICE indicates a potentially harmful situation which, if not avoided, may result in damage of the product itself or of adjacent objects.</b></i>

#### 3.1. Intended use

The data logger MSD200 has been designed and built solely for the intended use described in this manual, and may only be used accordingly. The technical specifications contained in this manual must be observed.

The data logger may be operated only in properly installed condition.

#### Improper use

Any other use is considered improper. Especially to note:

- The device should not be used for medical devices which receive, control or otherwise affect human life or physical health.
- The device should not be used in an explosive environment.
- The device should not be used in an atmosphere with chemically active substance.

## Design and functioning

### 4. Design and functioning

#### 4.1. Design

The device is designed in a plastic enclosure for DIN rail mounting. Indicators and control elements are located on the front side of the device. There are interlocks for DIN-rail mounting on the rear side.

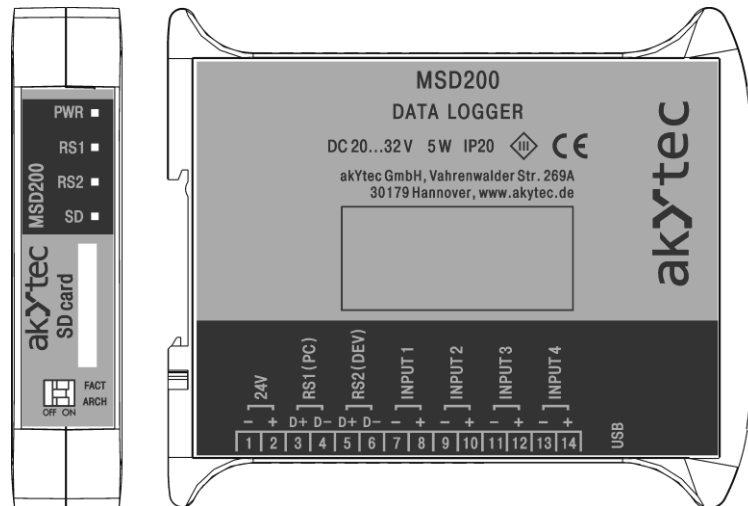

Fig. 4.1 External view

#### 4.2. Control elements

The operation of the device can be controlled with two DIP switches and four LEDs on the front panel.

Table 4.1 DIP switches

DIP switch	State	Description
FACT	ON	Network parameters of RS1 (PC) interface are reset to default: Device address = 16 Baud rate = 9.6 kbit/s
	OFF	Network parameters of RS1 (PC) interface (device address and baud rate) are set to user settings
ARCH	ON	Start data logging
	OFF	Stop data logging

Table 4.2 LEDs

LED	Indication	Description
PWR	Green	Supply voltage is inside permissible range
SD	Red	No memory card, data is stored to the built-in flash memory
	Red, blinking	Data loss, memory card or built-in flash memory is full
	Green	Logging paused, memory card can be changed
	Green, blinking	Logging is in progress, memory card is inserted and CANNOT be removed
	Yellow	Memory card is inserted, logging stopped
RS1	Not lit	No data exchange via RS1 or USB
	Green, blinking	RS1 or USB with user settings, data exchange is in progress
	Yellow	RS1 or USB with default settings
	Yellow, blinking	RS1 or USB with default settings, data exchange is in progress



## Design and functioning

LED	Indication	Description
RS2	Green	Interval between data packets
	Yellow	Interval between data packets, query cycle exceedance
	Red	Interval between data packets, timeout
	Blinking	Data packet received via RS2

## Installation

### 5. Installation

The operating conditions from the section 2.3 must be observed



**CAUTION**

#### ***Improper installation***

***Improper installation can cause serious or minor injuries and damage the control panel. Installation must be performed only by fully qualified personnel.***

#### 5.1. Mounting

- Align the upper slide of the DIN rail mounting groove with the DIN rail and push it onto the rail.
- Wire external connections in accordance with sec. 5.2 'Wiring' using plug-in terminal blocks (included).

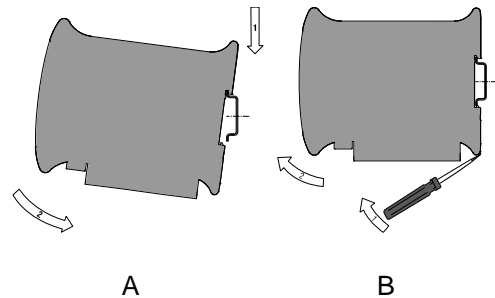

Fig. 5.1

#### **Removal:**

- Take off the terminal blocks without disconnecting the wires.
- Insert a screwdriver into the eyelet of the slide interlock, push it, and then remove relay from the rail.



**NOTICE**

***Removing of the terminal blocks may be performed only after powering off the device and all connected equipment.***

#### 5.2. Wiring

##### ***Dangerous voltage***

***Electric shock could kill or seriously injure.***



**DANGER**

***All electrical connections must be performed by a fully qualified electrician.***

***Ensure that the mains voltage matches the voltage marked on the nameplate.***

***Ensure that the device is provided with its own power supply line and electric fuse.***



**WARNING**

***Switch on the power supply only after wiring of the device has been completed.***

- The electrical connections are shown in Fig. 5.2 and the terminal assignments in Table 5.1.
- Connect the power supply to the terminals 24V / 0V.
- The maximum conductor cross-section for power supply is 1.5 mm<sup>2</sup>.



**NOTICE**

***Signal cables should be routed separately or screened from the supply cables. Only a shielded cable may be used for signal lines.***

- Connect the RS485 lines to terminals D+ and D-.
- Twisted pair cable should be used for the connection to RS485 interface. Maximal cable length is 1200 m.
- The USB interface enables hot plugging. The USB cable length should not exceed 3 m.

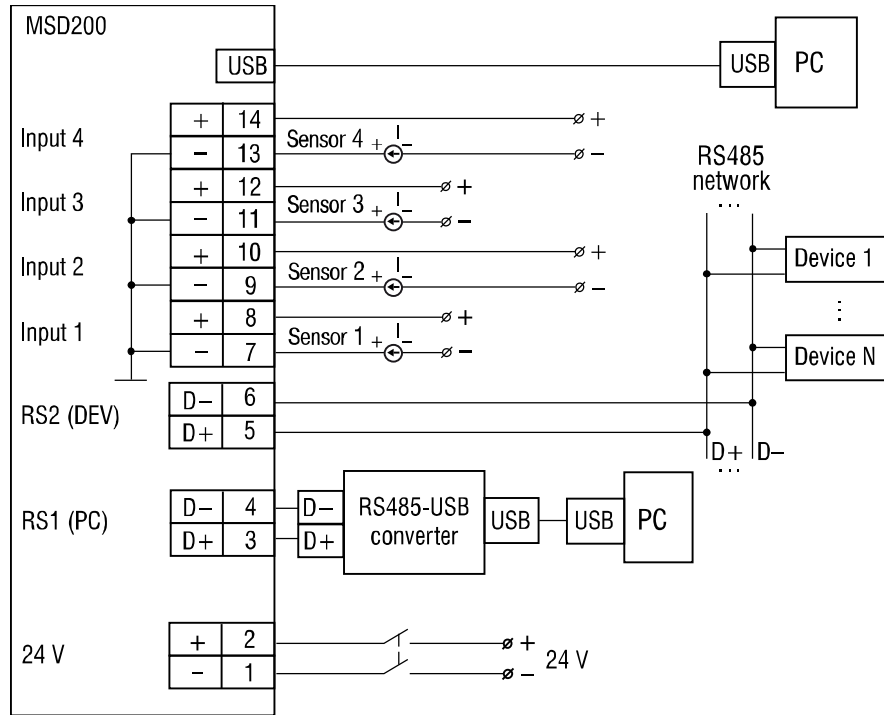

Fig. 5.2 Layout of external connections

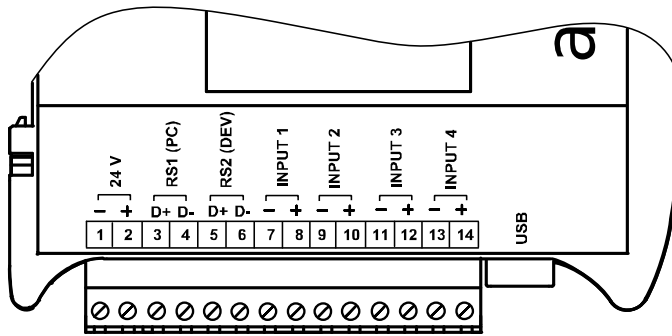

Fig. 5.3 Device connectors

Table 5.1 Terminal assignments

No	Indication	Description
1	24 V -	Power supply 24V
2	24 V +	
3	RS1 (PC) D+	RS485 Slave
4	RS1 (PC) D-	
5	RS2 (DEV) D+	RS485 Master/Slave
6	RS2 (DEV) D-	
7	INPUT 1 -	Analog input 1
8	INPUT 1 +	
9	INPUT 2 -	Analog input 2
10	INPUT 2 +	
11	INPUT 3 -	Analog input 3
12	INPUT 3 +	
13	INPUT 4 -	Analog input 4
14	INPUT 4 +	

## Installation

### 5.3. Quick replacement

MSD200 is equipped with plug-in terminal blocks which enable quick replacement of the device without disconnecting the existing wiring (Fig. 5.4).

To replace the device:

- power off all connected lines including power supply
- remove all detachable parts of the terminal blocks
- replace MSD200
- connect detachable parts with existing wiring to the device

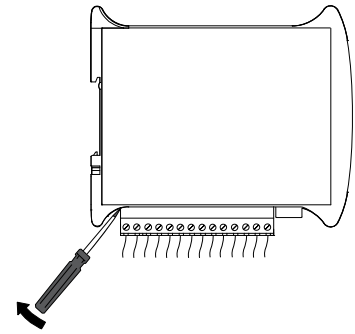









Fig. 5.4 Quick replacement

## MSD200 Configurator

### 6. MSD200 Configurator

#### 6.1. Software overview

Table 6.1 Basic control elements

Main menu	
File Device Language Help	Work with files and device configuration, select language or use help
Toolbar	
 Read all	Read configuration from the device
 Save all	Apply new configuration to the device
 Save changes	Apply the last changes to the device
 Save to file	Save configuration to a file
 Load from file	Load configuration from a file
 Start / Stop	Connect / disconnect MSD200 and PC
 Connection active	Connection status
Tabs	
Channels	Configuration of logging channels
File Manager	Log file management
View data	View received data
Settings	<ul style="list-style-type: none"> <li>– RS2 interface settings</li> <li>– Common parameters for logging</li> <li>– Digital signature</li> <li>– Date and time</li> <li>– Scheduled logging</li> </ul>
Analog inputs	Analog input settings
Memory card synchronization	Memory card synchronization settings
RS1 (PC) settings COM port: <input type="text" value="COM31"/> RS-232 <input type="radio"/> Modem <input checked="" type="radio"/>	MSD200 – PC connection parameters See section 6.2.1. for further details

Using the menu command '*Device>Default settings*' you can apply the factory settings to the configurator.

MSD200 Configurator allows creating device configurations in online and offline mode as well. The new configuration can be saved as a file and be used for configuring other MSD200.

The status of each variable parameter or parameter row is indicated by its background color:

pink	The parameter is not synchronized with the device parameter (the parameter has been changed but not applied to the device)
grey	The parameter cannot be changed

Changing and reading of parameters are performed according to the diagram in Fig. 6.1.

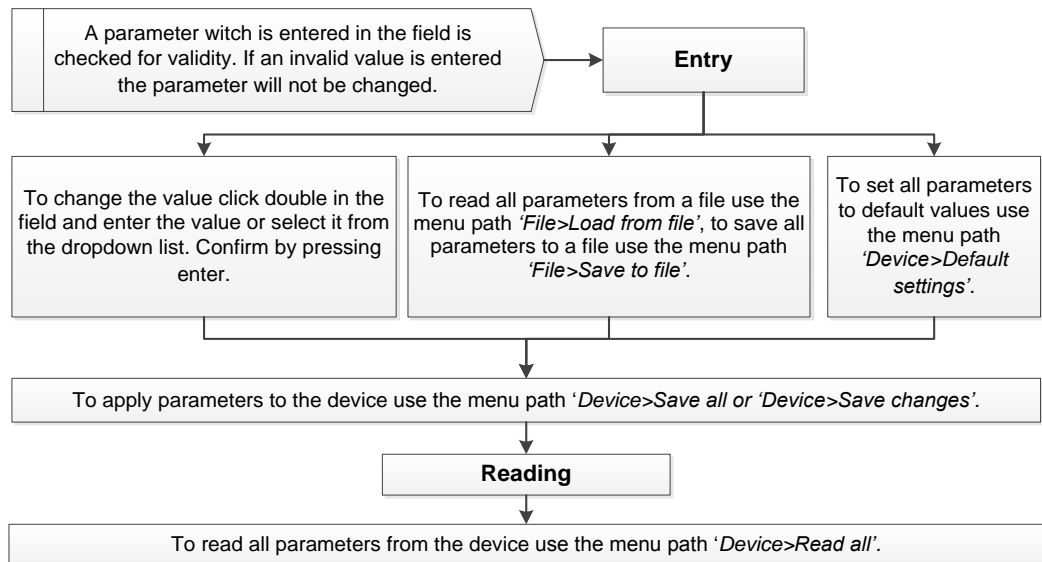

Fig 6.1

Alternatively you can use the toolbar items (see Table 6.1) and the buttons 'Read', 'Apply' and 'Default' for different parameter groups.

When you exit the program, all settings will be saved in an INI file. At program start all settings will be restored from the INI file. At the first start or if the INI file cannot be found, the program settings will be reset to defaults.

## 6.2. MSD200 – PC connection

► NOTICE

**When connecting MSD200 to a stationary PC, make sure that the computer provides grounding (this requirement does not apply to notebooks).**

Use the dialog box 'RS1 (PC) settings' (see Fig. 6.2) to establish the connection between the MSD200 and the PC. The content of the dialog box depends on the selected type of connection. Perform following steps to establish connection:

- Set the connection method:
  - o RS-232 – via the USB interface or RS1 (see 6.2.1)
  - o Modem – via a modem (see 6.2.2)
- connect the MSD200 to the PC
- start MSD200 Configurator on the PC
- set the network parameters in the Configurator

If the network parameters are correct, the connection will be established.

Use the button 'Start / Stop' to control the communication (see Fig. 6.2). The next item to the right (colored circle) indicates the status of connection:

- green – connection active
- red – connection inactive

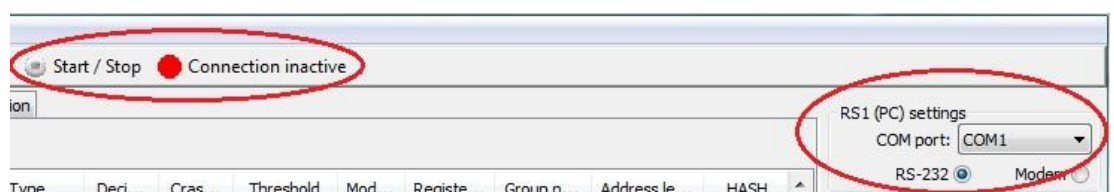

Fig. 6.2

## MSD200 Configurator

### 6.2.1. Connection via RS232

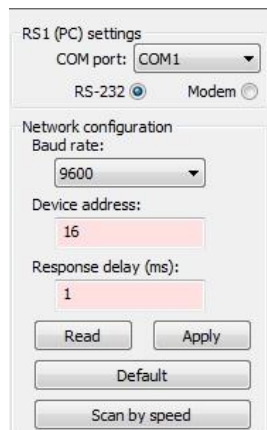

Fig. 6.3

1. Select a serial port. Appropriate port number can be found in Device Manager under topic '*Connections (COM and LPT)*'. If the device driver is successfully installed, a virtual COM port will appear in the list.
2. Set up network parameters. Connection will be established if the parameters of the device and in the configurator are equal.
3. If parameters of MSD200 are unknown, set network parameters of the device and in the software to default. Set switch '*FACT*' on the front panel of the device to '*ON*' position for implementing factory settings, and click '*Default*' in the dialog box '*RS1 (PC) settings*'.
4. When the connection is established, save changes by clicking '*Apply*'.

### 6.2.2. Connection via modem

This type of connection can be used only when network parameters of the MSD200 are already configured using RS232 connection (see section 6.2.1).

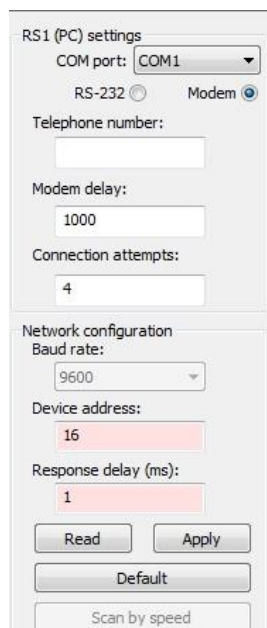

Fig. 6.4

1. Select a serial port. Appropriate port number can be found in Device Manager under topic '*Connections (COM and LPT)*'. If a driver is installed, a virtual COM port will appear in the list.
2. Set up parameters of the modem:
  - SIM card telephone number (MSISDN) for connection between the modem and the data logger
  - data exchange latency for mobile network (5000 ms is recommended)
  - maximum number of retries on failed connection with MSD200
3. Set up network parameters. Connection will be established if the parameters of the device and in the configurator are equal.
4. When the connection is established, save changes by clicking '*Apply*'.

### 6.3. Channels

When the connection between the configurator and the device is established, the parameters of MSD200 are read out and device settings become available.

To configure the logging channels use the tab '*Channels*' (see Fig. 6.5).

## MSD200 Configurator

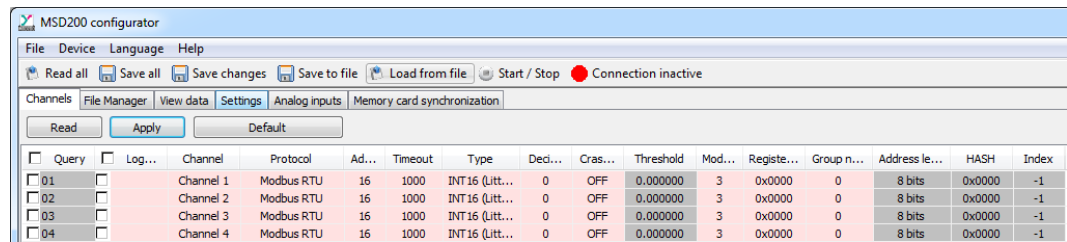

Fig. 6.5

There are 64 logging channels at your disposal. The following parameters can be set:

Table 6.3 Channel parameters

<input type="checkbox"/> Query <input type="checkbox"/> 01	When checked the channel will be queried in the Master mode
<input type="checkbox"/> Logging <input type="checkbox"/>	When checked the data of this channel will be logged
Channel Channel 1	Channel name in the log file (up to 30 characters)
Protocol Modbus RTU Modbus RTU	Network protocol or direct connection to one of the analog inputs <ul style="list-style-type: none"> <li>- ModBus RTU</li> <li>- ModBus ASCII</li> <li>- AKYTEC</li> <li>- Input 1</li> <li>- Input 2</li> <li>- Input 3</li> <li>- Input 4</li> </ul>
Address 16	Network address of the connected device Used only in Master or Spy mode (see 6.6)
Timeout 1000	Maximum time to wait for reply (0...65535 ms)
Type INT16 (Little-endian) INT16 (Little-endian)	Data type and byte order for transmitting over RS2 interface Most significant byte first: <ul style="list-style-type: none"> <li>- INT16 (Big-endian)</li> <li>- UINT16 (Big-endian)</li> <li>- INT32 (Big-endian)</li> <li>- UINT32 (Big-endian)</li> <li>- FLOAT32 (Big-endian)</li> </ul> Least significant byte first: <ul style="list-style-type: none"> <li>- INT16 (Little-endian)</li> <li>- UINT16 (Little-endian)</li> <li>- INT32 (Little-endian)</li> <li>- UINT32 (Little-endian)</li> <li>- FLOAT32 (Little-endian)</li> </ul> Mixed byte order (1-0-3-2) <ul style="list-style-type: none"> <li>- INT32 (Middle-endian)</li> <li>- UINT32 (Middle-endian)</li> <li>- FLOAT32 (Middle-endian)</li> </ul>
Decimal point 0	Number of decimal places for FLOAT32 data (0..5) or power of ten for INT16 and UINT32 data (-5..+5)



## MSD200 Configurator

Crash logging OFF	Enable/disable data logging in case of error conditions (no data, overload, line break etc.)
Threshold 0.000000 0.000000	Extra logging if the measured value changes abruptly The parameter specifies the maximum difference between the measured value and the last recorded value to trigger the extra logging. The extra logging is disabled if the Threshold is set to 0. When used in the application, the Threshold should be transformed into the data type specified in the parameter 'Type'
Modbus function 3	Modbus function for request - 0x03 (read holding registers) - 0x04 (read input registers)
Register address 0x0000	Register address for request
Group number 0 0	The possibility of data querying on several channels with one request The channels with the same Group number (non-zero) can be requested with one request. The grouped channels should use the same network address, the same Modbus function and consecutive Register addresses. Different data types are allowed.
Address length 8 bits	Address bits for AKYTEC protocol request 8 or 11 bits
HASH 0x0000	HASH parameter for AKYTEC protocol request
Index -1	Index for AKYTEC protocol request Can be set within the range -1...+32767 -1 means that the index is not used in the request

The logging process can be interrupted for up to two minutes, if channel parameters are changed during an active logging (ARCH switch in ON position). In order to ensure the data recording it is recommended to set the ARCH switch in OFF position before changing parameters.

### 6.4. File Manager

The tab 'File Manager' integrates all the necessary tools for operations with log files located on the memory card (see Fig. 6.7): viewing the file tree, information about storage capacity and free space on the card, copying files to PC, deleting files etc.

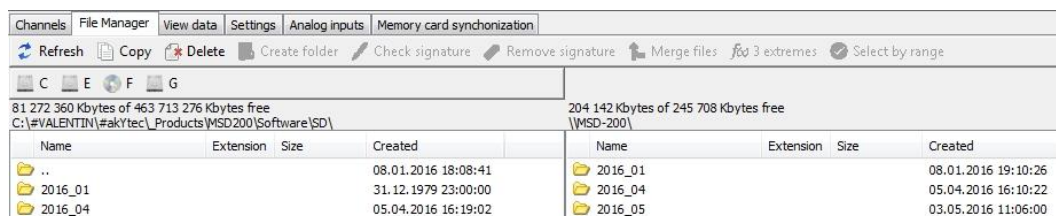







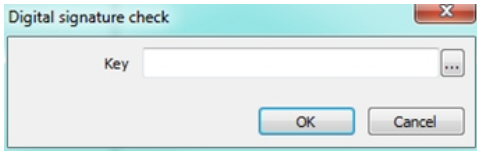



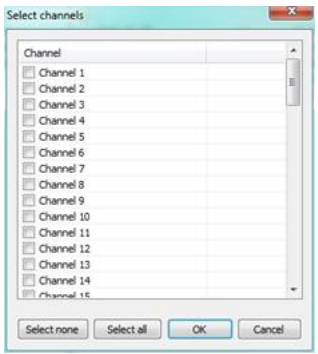

Fig. 6.7 File Manager

The tab is divided into 2 panes:

- the left pane shows the file tree on the PC
- the right pane shows the file tree on the memory card

A toolbar is located at the top of the window and contains the following controls:

*Table 6.4 File Manager toolbar items*

 Refresh	Refresh the memory card file tree (right pane)
 Copy	Copy selected folders and/or files from the memory card (right pane) to the opened folder on PC (left pane) Use CTRL+LMB for multiple choice, SHIFT+LMB to select adjacent files
 Delete	Delete selected files/folders (both panes)
 Create folder	Create a new folder on PC (left pane)
 Check signature	Verification of the digital signature in a CSV log file The key entered is compared with the key saved to MSD200. For creating a digital signature see section 6.7. To check the digital signature: <ol style="list-style-type: none"> <li>1. Click 'Refresh' to update the file tree</li> <li>2. Select the file on the memory card</li> <li>3. Choose the path to the file to be copied in the left pane and click 'Copy'</li> <li>4. Select the copied file and click 'Check signature'. The window appears:               <div data-bbox="794 943 1273 1093" data-label="Image">  </div> </li> <li>5. Click the button to the right of the input box to search for a key file on the PC. Select file and click 'OK'. If the archive file has not been edited, the message 'Digital signature matches' appears.</li> </ol>
 Remove signature	Create a copy of a log file without digital signature
 Merge files	Combine several CSV files on the PC into one
 <i>f(x)</i> 3 extremes	Statistical data processing finds 3 minima and 3 maxima in log data for selected channels. Proceed as follows: <ol style="list-style-type: none"> <li>1. Select a log file on PC and click '<i>f(x)</i> 3 extremes'. The window appears:               <div data-bbox="858 1556 1177 1908" data-label="Image">  </div> </li> <li>2. Select channels and click 'OK' to view the results</li> </ol>
 Select by range	Search in log data according to specified ranges

## MSD200 Configurator

### 6.5. View data

Use the tab 'View data' to view the current data for all channels.

Channels   File Manager   View data   Settings   Analog inputs   Memory card synchronization							
Polling cycle (ms)		10000		Apply			
No.	Value	No.	Value	No.	Value	No.	Value
1	Break	2	Break	3	Break	4	Break
5	Channel is off	6	Channel is off	7	Channel is off	8	Channel is off

Fig. 6.8 View data tab

Polling cycle is given in ms. The polling cycle depends on channel settings and its minimal value is about 500 ms. If the polling cycle is set to less than 500 ms, the next request will be sent right after receiving the response. Click 'Apply' to apply the changed value.

### 6.6. Settings

The tab 'Settings' contains all common settings for data logging. The tab consists of 5 groups:

- RS2 (DEV) settings
- Common settings
- Scheduled logging
- Digital signature
- Date and time

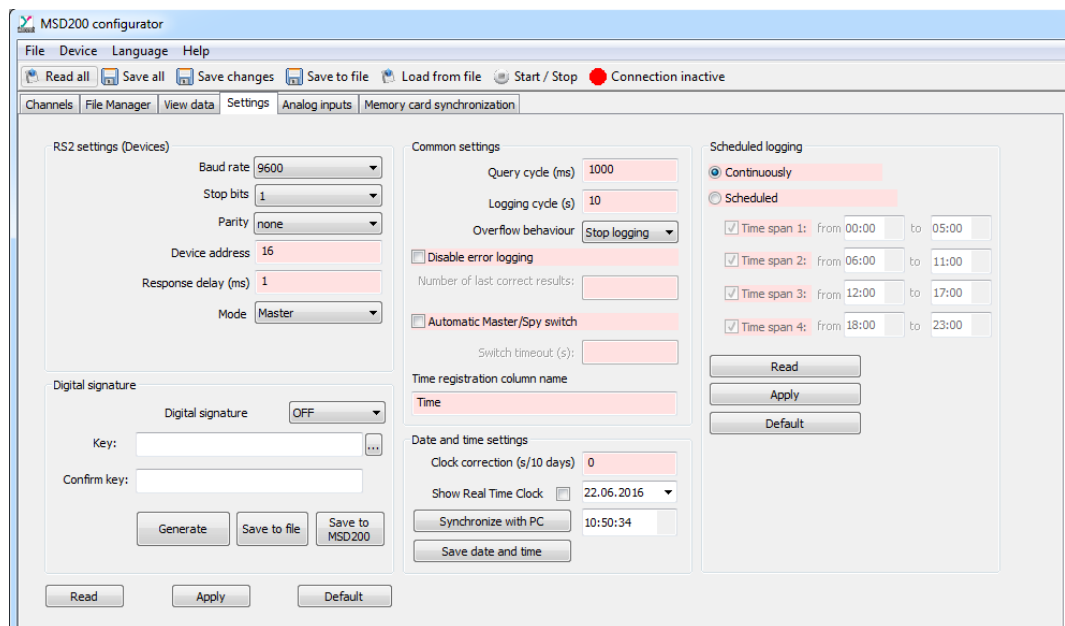

Fig 6.9 Settings tab

Table 6.5 Parameter group 'RS2 settings (Devices)'

Baud rate	9600	Baud rate (9600...15200 bit/s)
Stop bits	1	Number of stop bits (1, 2)
Parity	none	Parity (none, even, odd)

## MSD200 Configurator

Device address <input type="text" value="16"/>	Device network address
Response delay (ms) <input type="text" value="1"/>	Response delay (0...50 ms)
Mode <input type="button" value="Master"/> <input type="button" value="Slave"/> <input type="button" value="Slave Ext"/> <input type="button" value="Spy (only akYtec)"/>	Network mode <ul style="list-style-type: none"> <li>- Master</li> <li>- Slave (Modbus RTU only)</li> <li>- Slave Ext (Modbus RTU only)</li> <li>- Spy (AKYTEC only)</li> </ul>

### Master mode

- Polling and logging data from all Slave devices connected to the RS2 interface

### Slave mode

- For Modbus RTU protocol only
- Logging of data, received from Master using the function 0x10 *Writing Multiple Registers*
- It is not possible to poll the analog inputs in this mode.

### Slave Ext mode

- For Modbus RTU protocol only
- Unlike the Slave mode the new line in a log file is generated with the period set in the parameter '*Logging cycle*' (see Table 6.6).
- If the data from the master comes sooner than the period set, the data row will be saved immediately to prevent data loss.

### Spy mode

- For AKYTEC protocol only
- The device listens in on the network via the RS2 (DEV) interface to detect the response to master's request and performs the response data logging.
- The configuration in Spy mode is similar to the configuration in Master mode with the following exceptions:
  - o The parameter '*Query cycle*' is not used. The cycle is defined by the network Master. Thus, the '*Logging cycle*' should be adapted to the query cycle of the Master.
  - o If no data is received over a channel during the *Logging cycle*, the text 'no data' will be recorded in the log row for this channel, and the RS2 indicator will change to red.
  - o The parameter '*Response time*' is not used.

The buttons '*Read*', '*Apply*' and '*Default*' in the lower part of the window are used to control all parameter groups except the '*Scheduled logging*', which has its own control buttons.

Table 6.6 Parameter group '*Common settings*'

Query cycle (ms) <input type="text" value="1000"/>	Polling period in Master mode The parameter has no effect in Spy, Slave or Slave Ext modes. If all channels respond and the polling period for all channels does not exceed the Query cycle, the RS2 indicator lights green. If the real sum of polling times for all channels exceeds the Query cycle, the RS2 indicator will turn from green to yellow. If at least one of the polled channels does not respond, the RS2 indicator turns from green to red.
--	---

## MSD200 Configurator

Logging cycle (s) <input type="text" value="10"/>	Logging period The Logging cycle should be several times longer than the Query cycle in order to avoid data loss.
Overflow behaviour <input type="text" value="Stop logging"/>	The behavior at memory card overflow Two options available: <ul style="list-style-type: none"> <li>– Stop logging</li> <li>– Rewrite memory</li> </ul> At 'Rewrite memory' the data recordings beginning from the earliest will be deleted and the logging will be continued.
<input checked="" type="checkbox"/> Disable error logging Number of last correct results: <input type="text" value="1"/>	If error the previous correct value will be repeated, when checked
<input checked="" type="checkbox"/> Automatic Master/Spy switch Switch timeout (s): <input type="text" value="1"/>	Spy mode only When checked, the Master activity is monitored and the Master mode will be activated if no master activity detected. When the primary Master fails, the logger takes over its logging functionality. When the primary Master resumes operation, the logger returns to the Spy mode.

### 6.7. Digital signature

Use the parameter '*Digital signature*' to enable / disable the digital signature. The digital signature is intended for monitoring changes in the log files after memory card has been removed from the data logger or files has been copied to PC. A key should be created to use the digital signature.

Proceed as follows:



Fig. 6.10

#### Generated key

1. Select 'ON' to enable
2. Click 'Generate'
3. Click 'Save to MSD200'
4. Click 'Save to file', to save the key on PC
5. Click 'Apply' to initialize the key

#### Manually specified key

1. Select 'ON' to enable
2. Enter from 1 to 16 characters into the fields 'Key' and 'Confirm key'
3. Click 'Save to MSD200'. The key will be saved to device in 20...60 s.
4. Click 'Save to file' or just memorize
5. Click 'Apply' to initialize the key

The key cannot be read from the device memory.

The digital signature is formed in the log file on the memory card while the content of the RAM buffer is being transferred to the memory card, i.e. within 60 s after power on.

## MSD200 Configurator

### 6.8. Date and Time

Use the dialog box 'Date and time' to control the Real-Time Clock of the device. Available settings:

Table 6.7 Parameter group 'Date and Time'

Date and time settings Clock correction (s/10 days) <input type="text" value="0"/>	With this parameter a systematic clock error can be compensated in the range $\pm 200$ s/day
Show Real Time Clock <input type="checkbox"/>	If checked, RTC time and date are displayed
<input type="button" value="Synchronize with PC"/>	Copy time and date from PC clock to RTC of MSD200
<input type="button" value="Save date and time"/>	Apply the entered time and date to the device

Synchronization function of RTC ignores the 'Summer time'.

The capacity of the CR2032 backup battery is enough for powering the clock for 2 years minimum.

### 6.9. Log files

	A	B	C	D	E	F	G	
1	Time	Temp 1	Temp 2	Temp 3	Temp 4	Temp 5	Temp 6	Temp
2	09:26:47	25,3	28,5	28,5	28,5	30,5	30,4	
3	09:41:47	26,3	28,7	28,8	28,8	30,6	30,6	
4	09:56:47	27,1	29,2	29,3	29,2	31,3	31,3	
5	10:11:47	28,2	30,2	30,3	30,3	31,8	31,8	
6	10:26:47	28,3	30,7	30,8	30,7	32	32	
7	10:41:47	28,6	31,5	31,5	31,5	32,5	32,5	
8	10:56:47	29,1	31,8	31,8	31,8	33,1	33,1	
9	11:11:47	28,8	31,9	31,9	31,9	33	33	
10	11:26:47	29,1	31,9	31,9	31,9	33,5	33,5	
11	11:41:47	29,1	31,5	31,5	31,5	33,5	33,4	
12	11:56:47	28,5	31,5	31,6	31,5	33,5	33,5	
13	12:11:47	28,9	31,5	31,6	31,5	33,6	33,6	
14	12:26:47	29,3	32	32,1	32	33,8	33,9	
15	12:41:47	28,9	32,1	32,1	32,1	33,9	33,9	
16	12:56:47	29,3	32,2	32,3	32,3	34	33,9	

Fig. 6.11 Log file

- If the logging is enabled, a folder is created in the root directory of the memory card for each month, with a name in 'YYYY\_MM' format.
- A CSV file is created in this folder for each day of the month with a name in 'YYYY\_MM\_DD' format.
- The first column of the file contains the logging time.
- The first line contains the channel names given by user.
- Each data column corresponds to one of 64 channels.
- Each data line begins with a timestamp in 'HH:MM:SS' format with subsequent channel data separated by a semicolon.
- If the logging for a channel is disabled, a semicolon is only recorded in the data cell.

## MSD200 Configurator

11:26:20	32,5	37,4	30,2	30,2				
11:26:21	32,5	37,5	30,2	30,2				
11:26:22	32,5	37,5	30,2	30,2				
11:26:23	32,5	37,5	30,2	30,2	#0ED844528279D6A626AA3C220D7A2EF3#			

Fig. 6.12 Digital signature

- If the digital signature is enabled, it is recorded to the end of the last line, in the column 66.
- A digital signature is represented by a combination of 32 characters (0, 1, 2, 3, 4, 5, 6, 7, 8, 9, A, B, C, D, E, F) with a grid (#) at the beginning and at the end, e.g. #0ED844528279D6A626AA3C220D7A2EF3#.

### 6.10. Analog inputs

Use the tab 'Analog inputs' to set the parameters of analog inputs.

No.	Range	Filter	Min. physical value	Max. physical value
1	4-20 mA	100	0.000000	100.000000
2	4-20 mA	100	0.000000	100.000000
3	4-20 mA	100	0.000000	100.000000
4	4-20 mA	100	0.000000	100.000000

Fig. 6.12 Analog inputs tab

The buttons 'Read', 'Apply' and 'Default' are used to control all parameters of the group.

The device is factory calibrated. However, if some accuracy deviations appeared during operation, you can perform the adjustment to correct them. Proceed as follows:

1. Set the Range to 0-20 mA
2. Connect a current reference source of accuracy class at least 0.1 to the input
3. Set the current to 20 mA
4. Click the button 'Adjust'

The adjustment coefficients will be calculated and saved in the device persistent memory. The message with the information about adjustment results will appear.

## Memory card

---

### 7. Memory card

#### 7.1. Saving data

The data received from analog inputs and over RS485 interface is saved on memory card in two steps:

1. data is stored in a 16 kB data buffer
2. data is transferred to a memory card after 1 minute or when buffer is full

► NOTICE

***Do not save any files from PC to the memory card in order to avoid violation of the file structure on the card. However unnecessary files can be deleted.***

#### 7.2. Memory card replacing

Memory card should be removed from MSD200 during data accumulation in the data buffer. Data transfer from the buffer to the card occurs once per minute and lasts 3-4 seconds. This process is indicated by blinking green of the LED 'SD'.

When data transfer is completed, LED 'SD' stops blinking (lights green) and the card can be removed.

When the card is removed, the data will be still stored in 16 kB buffer. After 1 minute or when the buffer is full data will be stored in another 60 kB buffer.

If the both buffers become full, but the new card is still not inserted, some data can be lost. This will be indicated by red blinking LED 'SD' (see table 4.2).

► NOTICE

***Do not remove the memory card when recording is not completed, in order to avoid violation of the file structure on the card.***



## Modbus RTU

### 8. Modbus RTU

The protocol Modbus RTU is applied in the Slave mode to control the data logger. Following functions can be used:

Table 8.1 Modbus functions

Function	Description
0x03	Read Holding Registers Modbus Exception Code 2 (Illegal Data Address) will return when attempting to read the 'write only' or nonexistent registers
0x10	Write Multiple Registers Modbus Exception Code 1 (Illegal Function) will return when attempting to write the 'read only' or nonexistent registers
0x11	Report slave ID Reading the device name and the firmware version

- The parameters can be requested with one command and only in groups represented in tables 8.2 – 8.8. They are not available individually, except the parameters in the table 8.8. The parameters of the 'Channel data' subgroup (Table 8.8) can be read individually or with one command in a group of up to 40 consecutive channels, beginning from any.
- Reading or writing (functions 03, 10) of several parameter groups is not possible, otherwise the Modbus Exception Code 3 (Illegal Data Value) will be returned.
- Command execution time can be up to 30 seconds (time to delete a 1 GB file). If the command cannot be executed within 1 second, Modbus Exception Code 7 (Negative Acknowledge) will be returned. Until the current command execution is completed, further commands will be responded with the Modbus Exception Code 8 (Interface is used) and a current function code. It is impossible to cancel the execution process. After the function execution has been completed, communication will be continued as usual.

Table 8.2 RS1 (PC) interface

No	Parameter	Register	Valid value	Meaning	Data type	Default (Note)
<b>read/write, 3 registers</b>						
1	Baud rate, kbit/s	0x0000	0	1.2	UINT16	3
			1	2.4		
			2	4.8		
			3	9.6		
			4	14.4		
			5	19.2		
			6	28.8		
			7	38.4		
			8	57.6		
9	115.2					
2	Device address	0x0001	1..247		UINT16	16
3	Response delay (ms)	0x0002	0..50		UINT16	1

## Modbus RTU

Table 8.3 Settings

No	Parameter	Register	Valid value	Meaning	Data type	Default (Note)
<b>read/write, 13 registers</b>						
1	Baud rate, kbit/s	0x0040	0	1.2	UINT16	3
			1	2.4		
			2	4.8		
			3	9.6		
			4	14.4		
			5	19.2		
			6	28.8		
			7	38.4		
			8	57.6		
			9	115.2		
2	Stop bits	0x0041	0	1	UINT16	0
			1	2		
3	Parity	0x0042	0	none	UINT16	0
			1	even		
			2	odd		
4	Device address	0x0043	1..247		UINT16	16 (Slave mode)
5	Response delay (ms)	0x0044	0..50		UINT16	1 (Slave mode)
6	Mode	0x0045	0	Master	UINT16	0
			1	Slave (Modbus only)		
			2	Slave Ext (Modbus only)		
			3	Spy (AKYTEC only)		
7	Query cycle (ms)	0x0046	2..65535		UINT16	1000 ms
8	Logging cycle (s)	0x0047	1..65535		UINT16	10 s
9	Overflow behavior	0x0048	0	Stop logging	UINT16	0
			1	Rewrite memory		
10	Clock correction*	0x0049	-10000..+10000 s/10 days		INT16	0
11	Automatic Master / Spy switch	0x004A	0	OFF	UINT16	0
			1..65535	Switch timeout (s)		
12	Digital signature	0x004B	0	OFF	UINT16	0
			1	ON		
13	Disable error logging	0x004C	0	OFF	UINT16	0
			1..100	Number of repetitions of the last correct value		

\* Modbus Exception Code 90 returns, when exceeding the valid range

## Modbus RTU

Table 8.4 Data and time settings

No	Parameter	Register	Valid value	Meaning	Data type	Default (Note)
<b>read/write, 6 registers</b>						
1	Seconds	0x0080	0...59 s		UINT16	0
2	Minutes	0x0081	0...59 min			0
3	Hours	0x0082	0...23 h			0
4	Day	0x0083	1...31 d			1
5	Month	0x0084	1...12 mo			1
6	Year	0x0085	2010...2100 yr			2011

Table 8.5 Digital signature

No	Parameter	Register	Valid value	Meaning	Data type	Default (Note)
<b>write only, 8 registers</b>						
	Key	0x00C0.. 0x00C7	Key length 128 bits		UINT16[8]	0

Table 8.6 Channels

No	Parameter	Register	Valid value	Meaning	Data type	Default (Note)
<b>read/write, 31 registers</b>						
1	Query/Logging	0x0100 + (N-1)*64	Bit 0 (Logging)		UINT16	0 (channel number N = 1..64)
			0	OFF		
			1	ON		
			Bit 1 (Query)			
			0	OFF		
			1	ON		
2	Channel name	0x0101.. 0x0111	ASCII string ends with 0x00		CHAR[32]	'Channel N'
3	Protocol	0x0112	0	Modbus RTU	UINT16	0
			1	Modbus ASCII		
			2	AKYTEC		
			3	Input 1		
			4	Input 2		
			5	Input 3		
			6	Input 4		
4	Address	0x0113	0..2039	for AKYTEC 11 address bits	UINT16	16
			0..254	for AKYTEC 8 address bits		
			1..247	for Modbus		
5	Timeout, ms.	0x0114	10..65535		UINT16	1000 ms
6	Data type	0x0115	Little-endian (0-1-2-3)		UINT16	0
			0	INT16		
			1	UINT16		
			2	INT32		
			3	UINT32		
			4	FLOAT32		
			Big-endian (3-2-1-0)			
5	INT16					

## Modbus RTU

No	Parameter	Register	Valid value	Meaning	Data type	Default (Note)	
			6	UINT16			
			7	INT32			
			8	UINT32			
			9	FLOAT32			
			Middle-endian (1-0-3-2)				
			10	INT32			
			11	UINT32			
			12	FLOAT32			
7	Decimal point	0x0116	-5..5		UINT16	0	
8	Crash logging	0x0117	0	OFF	UINT16	0	
			1	ON			
9	Threshold	0x0118.. 0x0119	0 – dynamic logging disabled		FLOAT32	0	
10	Modbus function	0x011A	0	3	UINT16	0 (Modbus only)	
			1	4			
11	Register address	0x011B	0..0xFFFF		UINT16		
12	Group number	0x011C	0	no group	UINT16		
			1...32	group number			
13	Address length	0x011D	0	8 bits	UINT16		0 (akYtec only)
			1	11 bits			
14	HASH code	0x011E	0..0xFFFF		UINT16		0 (akYtec only)
15	Index	0x011F	-1..32767		UINT16	-1 (akYtec only)	

Table 8.7 Analog inputs

No	Parameter	Register	Valid value	Meaning	Data type	Default (Note)
<b>read/write, 6 * 4 = 24 registers</b>						
1	Range	0x1100.. 0x1105	0	4-20 mA	UINT16	0
			1	0-20 mA		
			2	0-5 mA		
2	Filter, ms	0x1106.. 0x110B	100..65535		UINT16	100
3	Min. physical value	0x110C.. 0x1111	-10 <sup>9</sup> ..10 <sup>9</sup>		FLOAT32	0
4	Max. physical value	0x1112.. 0x1117	-10 <sup>9</sup> ..10 <sup>9</sup>		FLOAT32	100

Table 8.8 Operating parameters

No	Parameter	Register	Valid value	Meaning	Data type	Note
<b>Channel data (read only, 3 * 64 = 192 registers) *</b>						
1	Status	0x2000 + (N-1)*3.. 0x20BF	Byte 0, bits 0..3 (channel status)		UINT16	channel number N = 1..64
			0	ON		
			1	OFF		
			2	Timeout		

## Modbus RTU

			3	Overload (analog inputs)		
			4	Break (analog inputs 4-20 mA)		
			5	Modbus exception code, byte 1		
			Byte 0, bits 4...7 (data type)			
			0	INT16		
			1	UINT16		
			2	INT32		
			3	UINT32		
			4	FLOAT32		
			Byte 1 (Modbus exception code)			
2	Measured value		Bytes 2..5		FLOAT32	most significant bytes are set to 0 for short data types
<b>Device status (read only, 19 registers)</b>						
1	Last program start cause	0x20C0	Bit 0	Hardware reset	UINT16	
			Bit 1	Powered on		
			Bit 2	Software reset		
			Bit 3	Independent watchdog timer		
			Bit 4	Window watchdog timer		
2	Last network error	0x20C1	0..255		UINT16	0 at power on
3	Memory signa- ture	0x20C2... 0x20D1			UINT16 [16]	
4	Status flag	0x20D2	Bit 0	Default settings	UINT16	
			Bit 1	FLASH failure		
			Bit 2	Logging switch status		
			Bit 3	Logging data loss		
			Bit 15	No memory card		
<b>Analog inputs (read only, 8 registers)</b>						
	Input value	0x3000.. 0x3007			FLOAT32 [4]	
<b>Adjustment (read only, 5 registers)</b>						
	Result	0x3010	0	OK	UINT16	
			1	ErrRMS **		
			2	ErrValue		
			3	ErrFlash		
			4	Timeout		
			Byte 1-2	RMS **	FLOAT32	
			Byte 3-4	Value	FLOAT32	

\* It is possible to read the data from up to 40 consecutive channels with one command.

\*\* Root Mean Square

## 9. Maintenance

**CAUTION**

*Insufficiently qualified personnel are endangered or endanger others. It can cause minor injuries, property or environmental damage.*

The maintenance includes:

- cleaning the enclosure and terminal blocks from dust, dirt and debris
- checking the fastening of the device
- checking the wiring (connecting leads, fastenings, mechanical damage)
- check the Real-Time Clock and correct if necessary

The device should be cleaned with a damp cloth only. No abrasives or solvent-containing cleaners may be used. The safety information in section 3 must be observed when carrying out maintenance.

## Transportation and Storage

---

### 10. Transportation and Storage

Pack the device in such a way as to protect it reliably against impact for storage and transportation. The original packaging provides optimum protection.

If the device is not taken immediately after delivery into operation, it must be carefully stored at a protected location. The device should not be stored in an atmosphere with chemically active substances.

Permitted storage temperature: -15...+55 °C

▶ NOTICE

***The device may have been damaged during transportation.***

***Check the device for transport damage and completeness!***

***Report the transport damage immediately to the shipper and akYtec GmbH!***

## Scope of delivery

---

### 11. Scope of delivery

- MSD200 1
- Short guide 1
- USB stick with software and documentation 1